



ENGINEERING EXCELLENCE

Installation Guide

Single Handle Wallmount Roman Tub Set:





- 4MT840

This product meets the following standards:

- ASME A112.18.1
- ANSI A117.1
- CUPC / IAPMO LISTED / ADA COMPLIANT

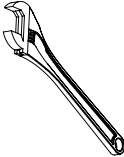
Thank you for purchasing this pioneer quality product.

Tools Required

				
Adjustable Wrench	Teflon Tape	Rags	3/32" Allen Wrench	

Prior to Installation

- Observe all local plumbing and building codes before you begin installation.
- Carefully shut off both hot and cold water supplies.
- Plug the tub drain with a soft cloth to prevent intrusion of debris or the loss of any parts.
- Pioneer reserves the right to make changes in the design of faucets without notice.

Valve Installation

- **Note:-** The wall bracket (A) requires special framing and support considerations. Please pay special attention to minimum and maximum dimension recommendations noted.
- Refer to the specification for additional dimension information.
- A suggested framing example is shown. Each installation may have different framing requirements than shown.
- Construct the framing for your installation.
- Attach the wall bracket (A) to the framing with six panhead mounting screws (B) provided with the wall bracket (A).
- Verify that the installation is correct and leveled. Also verify the wall bracket (A) is firmly secured to the framing.

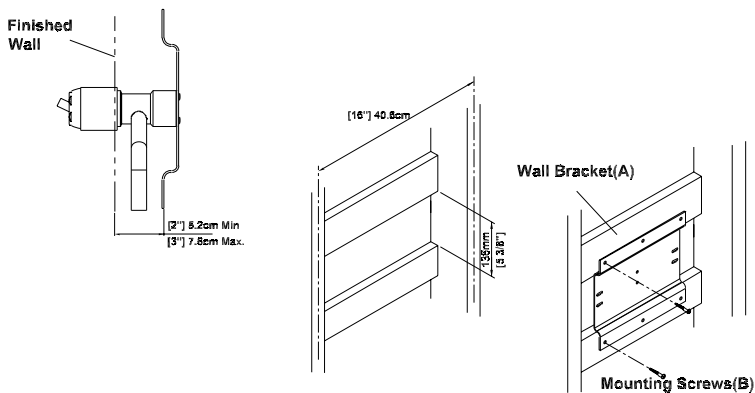

Valve Installation

- Attach the valve body (E) to the wall bracket (A) with the screws (D) and washers (C) provided.
- Tighten the screws (D) securely
- Before soldering remove all the components (like retainer sleeve (N), ceramic cartridge (O), retainer nut (P) and retainer ring (Q)) to prevent internal damage. Solder the 1/2" hot and cold water supply lines to the valve. After soldering replace all the components removed.
- Position a bucket in front of the spout shank. and turn on the main water supplies.
- Slowley open the valve and allow hot and cold water to flow from the spout shank for about a minute.
- Close the valve, carefully inspect all the connections for leak. repair if necessary.
- Reattach mud guards(F) to the valve.

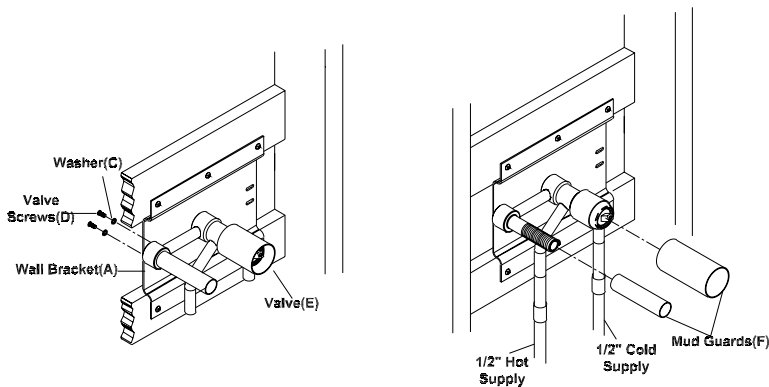

Trim Installation

- **Note:-** To make sure proper fit and appearance, do not oversize the spout and handle shank holes.
- Complete the finished wall with one 1-1/2" hole for spout and one 2" hole for valve. Both holes should be 4" center apart.
- Remove the guards (J) once the finished wall is complete.
- Place the spout escutcheon (L) with the rubber washer underneath to the spout shank (K). Thread spout (M) on the spout shank (K). till against the finished wall. Make sure the spout (M) faces downward.
- Install handle and valve escutcheon (N). Ensure washer is behind the valve escutcheon (N) to form watertight seal. Tighten the allen screw (O) and snap on button (P).

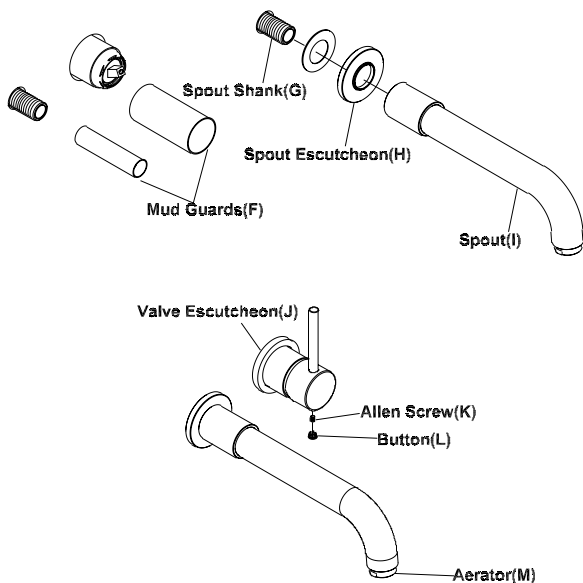

To Set or Adjust Temperature Limit Stop

Caution: Valve is preset at the factory test at maximum. Adjust as necessary. Please see the instructions below:

- Turn off water and relieve the pressure.
- Remove handle by removing button and loosening allen screw lift off handle.
- Counterclockwise unscrew retainer ring (U) and retainer nut (T) counterclockwise.
- Use two fingers to raise the red adjustment ring (V).
- Turn adjustment ring counterclockwise to decrease the temperature and clockwise to increase the temperature. Replace the adjustment ring.
- Reassemble and test until desired safe temperature is reached. (Note: Ensure proper alignment of cartridge with notch in valve body.)

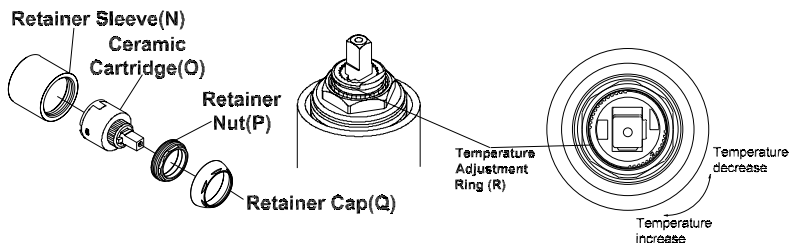

For more care information or trouble shooting inquiries about your Pioneer Product, please see the contact information on the back page.



ENGINEERING EXCELLENCE

3325 S. Garfield Ave. | Commerce, CA 90040
Telephone: (800) 338-9468 | (323) 888-8873 | Fax: (323) 888-9515
Hours: M - F, 7:30am to 5:00pm PST
www.pioneerind.com