



ENGINEERING EXCELLENCE

## Installation Guide

Two Handle Lavatory Widespread Faucet:





- |           |           |           |
|-----------|-----------|-----------|
| • 3PR200* | • 3BR400* | • 3BR530* |
| • 3DM200* | • 3BR410* | • 3MT400* |
| • 3DM300* | • 3BR420  | • 3MT500* |
| • 3CB200* | • 3BR430* | • 3CL400* |
| • 3GB200* | • 3BR500* | • 3CS400* |
| • 3BL200* | • 3BR510* | • 3BR520  |

This product meets the following standards:

- ASME A112.18.1
- ANSI A117.1
- ANSI / NSF 61, SECTION 9
- CUPC / IAPMO LISTED /\* ADA COMPLIANT
- CONTAINS NO MORE THAN 0.25% WEIGHTED AVERAGE LEAD CONTENT

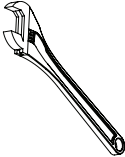
**Thank you for purchasing this Pioneer quality product.**

**Tools Required**

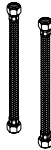
				
Adjustable Wrench	Teflon Tape	Rags	3/32" Allen Wrench	Flex Hose

**Prior to Installation**

- Observe all local plumbing and building codes before you begin installation.
- Carefully shut off both hot and cold water supplies.
- Plug the sink drain with a soft cloth to prevent intrusion of debris or the loss of any parts.
- Pioneer reserves the right to make changes in the design of faucets without notice.

## Faucet Installation

1. Place the spout escutcheon (B) underneath of the spout (A). Ensure the gasket (C) is placed underside of the escutcheon (B). Slide the spout (A) through center mounting hole. Slide the spout mounting bracket (D) through spout shank from underside of center mounting hole.
2. Thread and tighten the spout mounting nut (E). Do not overtighten.
3. Ensure the washer (F) inside the 'Y' connector (G). Connect the 'Y' connector (G) to the spout shank. Place teflon tape at the end of the spout shank if necessary. Do not overtighten.

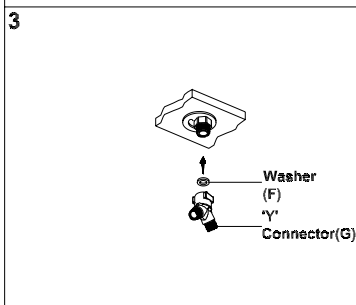
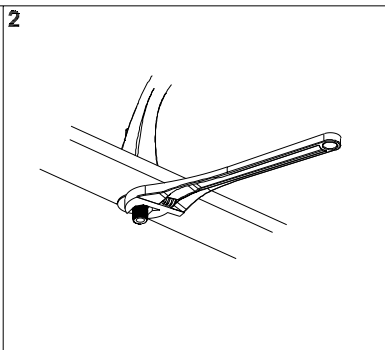
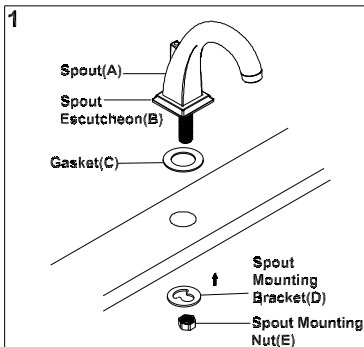

## Faucet Installation

- The hot and cold side valves (H) are marked with 'HOT' and 'COLD' on the valve. Place steel washer (J) and rubber washer (I) underneath of the 'HOT' side valve. Slide the valve through mounting hole. Place rubber washer (I) and steel washer (J) to the valve from underneath of the mounting surface.
- Ensure the handles are position correctly. Tighten the locknut (K) to the valve (H) with the help of 1-11/32" socket. Install the 'COLD' side valve same as 'HOT' side valve.
- Connect the valve outlet hose connector (L) to the 'Y' connector (G).
- Ensure all the connections are installed correctly.

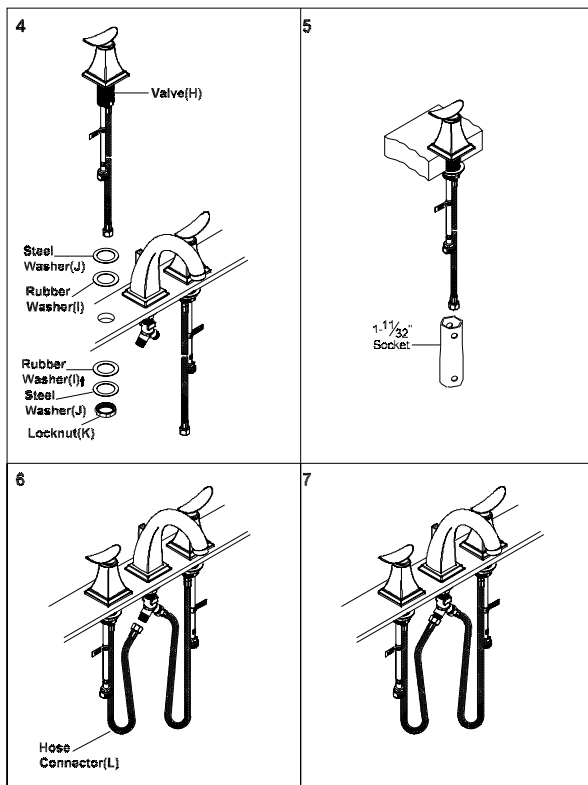

## Faucet Installation

8. Remove the pop-up stopper (M) and pop-up flange (N) from the pop-up assembly.
9. Apply adequate amount of plumbers putty underside of pop-up flange (N). Then insert pop-up drain assembly from underside of the sink and secure the pop-up flange (N) from the top.
10. Rotate the drain body so that horizontal rod hole faces back of the faucet. Hold the pop-up assembly in place and tighten the locknut (O).
11. Remove the excess putty. Connect the trap (P). ( check manufacturer's instructions for installation)

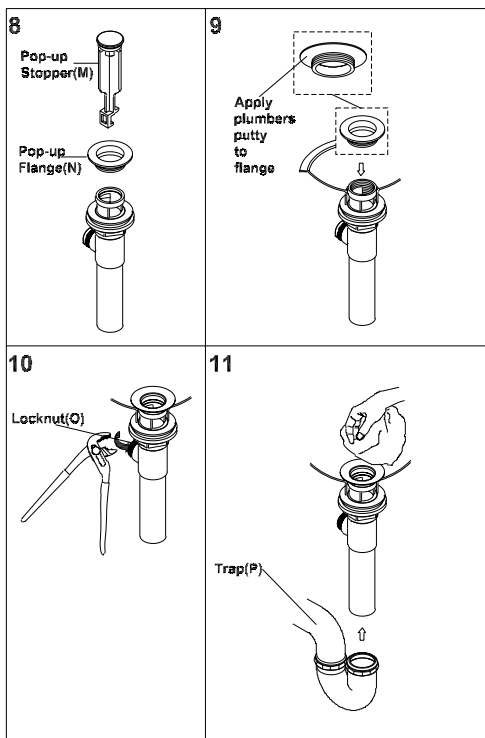

## Faucet Installation

12. Remove rod nut (Q).
13. Ensure the washers (R) is in place. Insert rod (S). Tighten the rod nut (Q).
14. Push rod down to open drain. Insert the pop-up stopper (M) carefully. Test if the pop-up stopper (M) is working properly.
15. Connect pop-up bracket to the rod by using clip (V). Tighten the thumb-screw (U) to connect pop-up bracket to pop-up lift rod.

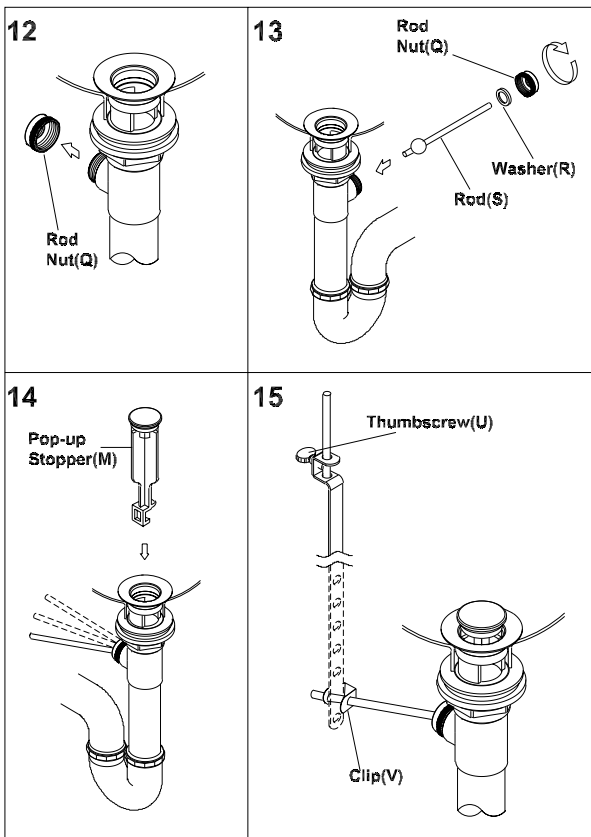

## Faucet Installation

16. Connect the valves to inlet supply lines. Connect the supply stops to the inlet supply lines (left is hot water supply and right is cold water supply). Make sure inlet supply lines are securely tightened. Do not over-tighten. Turn on supply stop. Remove aerator (W).
17. Check for any leaks. Make sure all the connection are secure.
18. Open the handles, flush and allow water to run at full flow for at least one minute. Close the handles.
19. Replace aerator (W).

16

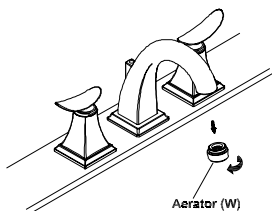

17

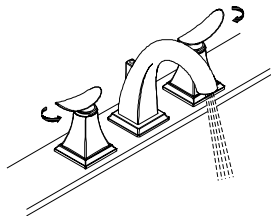

18

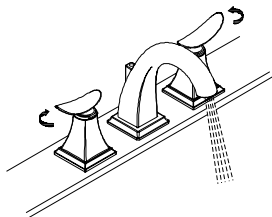

19

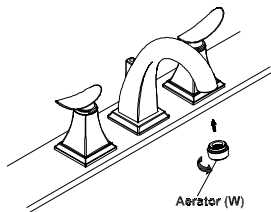

For more care information or trouble shooting inquiries about your Pioneer Product, please see the contact information on the back page.



ENGINEERING EXCELLENCE

3325 S. Garfield Ave. | Commerce, CA 90040  
Telephone: (800) 338-9468 | (323) 888-8873 | Fax: (323) 888-9515  
Hours: M - F, 7:30am to 5:00pm PST  
[www.pioneerind.com](http://www.pioneerind.com)