

CODE NUMBER

3782693

DESCRIPTION

0.5 gpf, Polished Chrome Finish, Single Flush, Hardwired, Sloan® Exposed Sensor Urinal Flushometer.

DETAILS

- Flush Volume: 0.5 gpf (1.9 Lpf)
- Finish: Polished Chrome (CP)
- Power Type: Hardwired (HW)
- Battery Life: 3 years
- Valve: Diaphragm
- Valve Body Material: Semi-red Brass
- Fixture Type: Urinal
- Fixture Connection: Top spud
- Rough-In Dimension: 11 ½" (292mm)
- Spud Coupling: ¾" (19mm)
- Supply Pipe: ¾" (19mm)

FEATURES

- PERMEX® High-Efficiency Synthetic Rubber Diaphragm with Linear Filtered Bypass with Vortex Cleansing Action™
- Handle Packing, Main Seat, Stop Seat and Vacuum Breaker Molded from PERMEX® Rubber Compound for Chloramine resistance
- "User in View" Flashing LED
- No External Volume Adjustment to Ensure Water Conservation
- True Mechanical Override Flush Button
- 72-Hour Sentinel Flush
- Sweat Solder Adapter w/Cover Tube and Cast Wall Flange with Set Screw
- 3/4" IPS screwdriver Bak-Chek® angle stop with vandal resistant stop cap



COMPLIANCES & CERTIFICATIONS

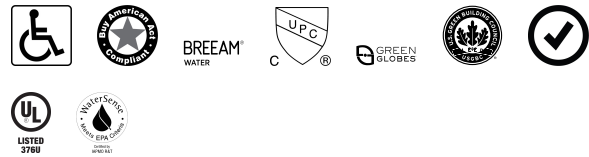

(ADA Compliant, BAA Compliant, BREEAM Water Credit, cUPC Certified, Green Globes Water Credit, LEED V4 Water Efficiency Credit, Satisfies LEED Credits, UL Certified, WaterSense Listed)

RECOMMENDED SPECIFICATION

Valve Body, Cover, Tailpiece and Control Stop shall be in conformance with ASTM Alloy Classification for Semi- Red Brass. Valve shall be in compliance with the applicable sections of ASSE 1037 and ANSI/ASME 112.19.2.

ELECTRICAL SPECIFICATIONS

- Battery Life: 3 years
- Transformers:
 - 0345095
 - 0345125

VALVE OPERATING PRESSURE (FLOWING)

15-80 PSI (103-552 kPa). Specific fixtures may require greater minimum flowing pressure - consult manufacturer requirements.

DOWNLOADS

- [Sloan Exposed Installation Instructions](#)
- [Sloan Exposed \(Spanish\) Installation Instructions](#)
- [EBV-500/550-A Installation Instructions](#)
- [Control Stop Repair and Maintenance Guide](#)
- [Flush Connections Flanges Repair and Maintenance Guide](#)
- [Tail Piece Repair and Maintenance Guide](#)
- [Sloan Flushometer Repair and Maintenance Guide](#)
- [Additional Downloads](#)

NOTES

All information contained within this document subject to change without notice.

Sloan 10500 Seymour Ave, Franklin Park, IL 60131

Phone: 800.982.5839 • Fax: 800.447.8329 • sloan.com

Looking for other variations of the SLOAN 186 SFSM product?
[View the general spec sheet with all options.](#)

[Find a compatible urinal](#) for this flushometer.

[Find a compatible water closet](#) for this flushometer.

Watersense compliant when used with a WaterSense compliant fixture

ROUGH-IN

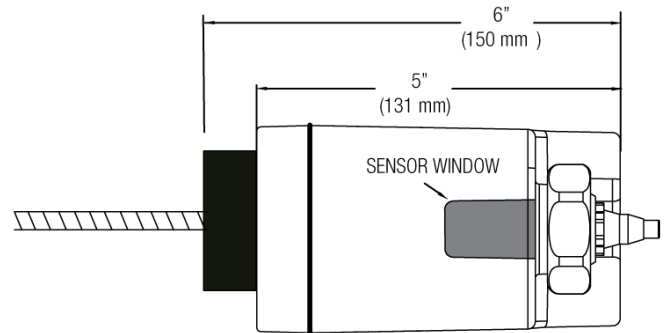
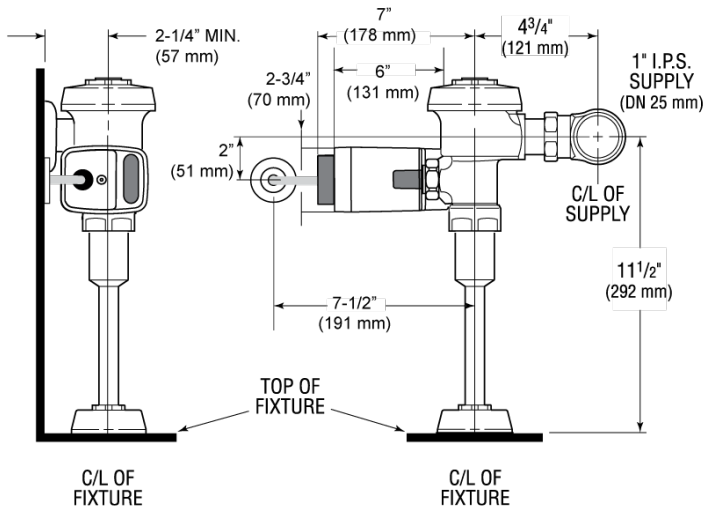

Sloan 10500 Seymour Ave, Franklin Park, IL 60131

Phone: 800.982.5839 • Fax: 800.447.8329 • sloan.com